

# KOHLER

## 科勒厨卫经典

### K-2660T-1 拂朗 FOREFRONT

### 长方形时尚脸盆 RECTANGULAR VESSEL 切割图/安装说明书

#### CUT-OUT TEMPLATE / INSTALLATION INSTRUCTIONS

#### 安装之前

- 留意当地所有给排水及建筑规定。
- 检查污水管及供水管，如有需要请更换。
- 安装之前，先开启新脸盆的包装，并小心检查脸盆是否有损坏，再将脸盆放回包装箱内，到安装时才取出。
- 若为更换新脸盆，须确保现有的柜台孔口与新脸盆的切割图相同或较后者小。
- 请使用同时印在此说明书上的切割图，标划正确的切割位。
- 科勒脸盆是根据美国标准制造的，与美式洗脸盆配件相配，其它洗脸盆配件可能与之不相配。

#### 所需工具及物料 (不随货供应)

- 模板(已提供)
- 护眼镜
- 炭笔
- 剪刀
- 卷尺
- 涂油灰刀
- 水管用油灰
- 锯锯
- 匙孔线锯或手提电锯
- 钻(直径为13mm钻头或更大)
- 活动板钳
- 喉管板钳
- 切管刀

#### 尺寸图

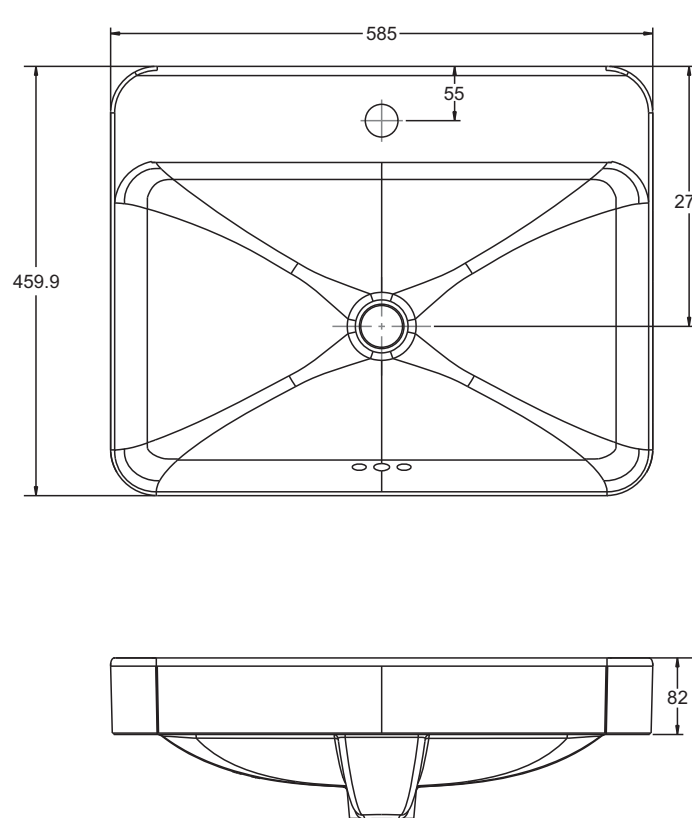

#### BEFORE YOU BEGIN

- Observe all local plumbing and building codes.
- Inspect the waste and supply tubing; replace if necessary.
- Prior to installation, unpack the new lavatory and carefully inspect it for damage. Return the lavatory to its protective carton until you are ready to install it.
- For replacement installations, make sure the existing cutout is the same or smaller size as the new lavatory.
- Use the template supplied with the lavatory to mark correct size cutout.
- Kohler lavatory is made according to American National Standard that it can match the American lavatory fittings. Any other lavatory fittings may not fit for Kohler lavatory.

#### TOOLS AND MATERIALS (Not Supplied)

- Template(supplied)
- Safety glasses
- Pencil
- Scissors
- Tape measure
- Putty knife
- Plumbers putty
- Hacksaw
- Kayhole saw or saber saw
- Drill (13mm or 1/2" dia. drill bit or larger)
- Adjustable wrench
- Pipe wrench
- Tubing cutter

#### ROUGH-IN

Unit: mm  
单位: 毫米

#### 拆除旧脸盆

- 关掉水龙头的供水源。
- 打开龙头阀门，然后除供水管。
- 再旋开排水装置，并拿开弯管。
- 移走旧脸盆。

#### 安装新脸盆

- 将切割图沿切割线切出。
- 将切割图放在盥洗台上，确保脸盆、水龙头和防溅挡板之间有足够距离。
- 检查盥洗台下的储物柜也有足够空间。

- 用炭笔沿切割图在盥洗台面划线。
- 再次检查脸盆、水龙头、防溅水板及储物柜的空间及距离。如有需要可调整切割图的位置。

- 用一个13mm的钻头，在切割口内侧钻一个导孔。
- 沿着自切割图勾划出来的铅笔线内侧切开台面。

- 暂时将脸盆放入台面开口，校正位置。
- 小心：提防身体受伤或损坏产品。**因大型脸盆相当重，需找人帮您一起搬动及安放。

- 用炭笔沿脸盆外缘在盥洗台上划线。
- 然后将脸盆移开。
- 按照制造商的指引，安装水龙头和排水管道。
- 沿炭笔导线内侧涂两滴密封胶。
- 用涂油灰刀将其抹匀。

- 小心地将脸盆置于台面切口适当位置，向下按牢。

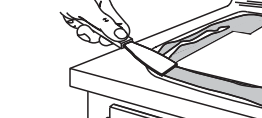
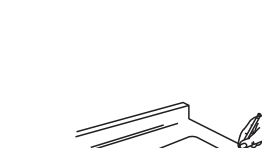
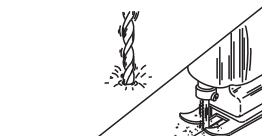
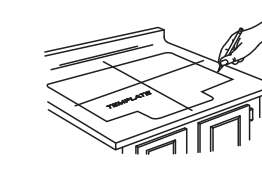
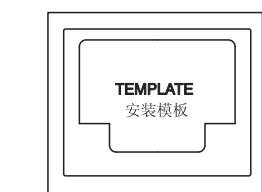
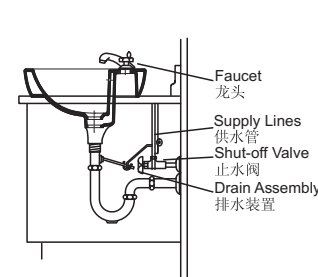

#### REMOVE EXISTING LAVATORY

- Turn off the water supply to the faucet.
- Open the faucet valves, then disconnect the supply lines.
- Disconnect the drain assembly and remove the trap.
- Remove the existing lavatory.

#### INSTALL NEW LAVATORY

- Cut the template on the cutout line.
- Position the template on the countertop to ensure clearance between the lavatory, faucet, and backsplash.
- Verify cabinet clearance beneath the countertop.

- Trace the template on the countertop with a pencil.
- Re-check the clearance between the lavatory, faucet, backsplash, and cabinet. Adjust the template accordingly.

- Drill a 13mm hole on the inside of the cutout opening.
- Cut the opening in the countertop along the inside edge of the pencil line.

- Temporarily position the lavatory in the opening, and adjust to fit.
- CAUTION: Risk of personal injury or product damage.** Large lavatories are very heavy. Get help lifting the lavatory into place.

- Trace a pencil line around the outside edge of the lavatory.
- Remove the lavatory.
- Install the faucet and drain according to the manufacturers instructions.

- Apply two beads of sealant to the inside of the pencil line.
- Spread the sealant evenly with a putty knife.

- Carefully position the lavatory in the cutout, and press down firmly.

#### 小心：提防身体受伤或损坏产品。

- 因大型脸盆相当重，需找人帮您一起搬动及安放。

- 立即擦去多余的密封胶，如脸盆外缘与台面间有缝隙，即用胶填满。

- 检查脸盆的位置准确。
- 最少待三十分钟，让密封胶干透后，方可继续进行安装。

- 联接水龙头供水管。
- 联接排水装置。
- 开启水龙头阀门，检查有无渗漏。
- 用非腐蚀性清洁剂来清洁。

#### 用户须知 (护理和清洁)

为保持脸盆光洁如新，须确保每次使用后彻底冲洗干净，切勿使用腐蚀性的清洁剂，以免刮花及破坏脸盆的表面。要清除顽固污垢，油漆或柏油，可使用松油或油漆稀释剂。

#### 维修零件

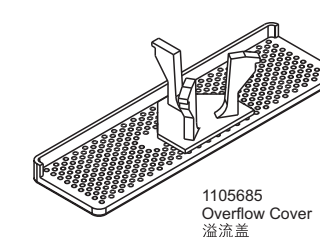

1109397-T01-B

© 版权为科勒中国有限公司所有，2009  
© Copyright Kohler China Ltd., 2009

Outline  
外形轮廓

430 mm

沿此线切割  
CUT ALONG THIS LINE

118 mm

410 mm

491 mm

Finished Wall  
墙面

> 27 mm 盆后应预留足够的空间  
Please reserve enough space at the back of the lavatory

R10