

Product

- Purist® single lever basin mixer

Kohler Code

14402A-4AND-*

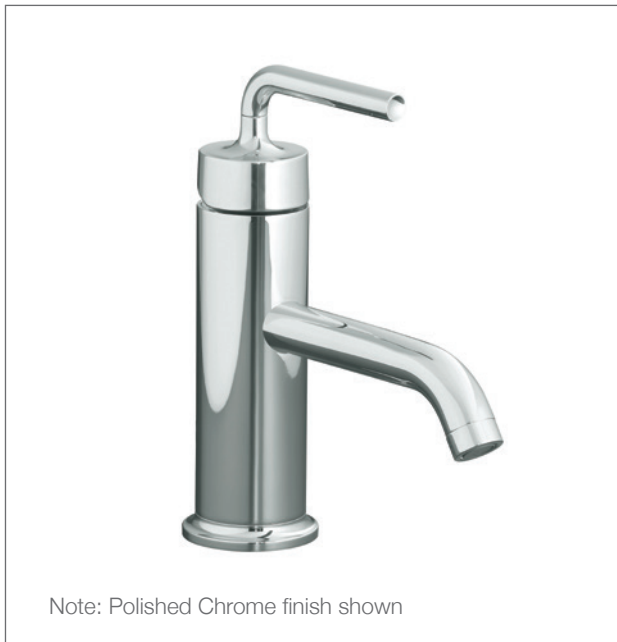

Included Components

- Braided stainless steel hoses





Features

- Choice of 5 colours
- Metal construction
- Ceramic disc cartridge
- Suitable for mains pressure
- KOHLER finishes resist tarnishing and corrosion



WELS RATING
(5 Star 6.0 Litres / min)

PVD Colour Options (Colour swatches indicative only)

-  14402A-4AND-CP - Polished Chrome
-  14402A-4AND-BV - Vibrant Brushed Bronze
-  14402A-4AND-BN - Vibrant Brushed Nickel
-  14402A-4AND-PGD - Vibrant Moderne Polished Gold
-  14402A-4AND-RGD - Vibrant Rose Gold

Related Products

- Purist accessories
- Purist tapware

Technical Details

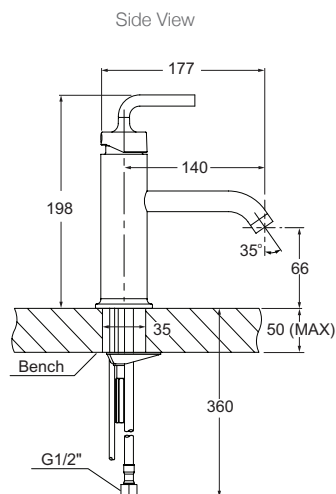

G½" is equal to BSP½"

Installation Notes:

- Optimum working pressure 300-500 kPa.
- Maximum hydrostatic pressure 800 kPa (This pressure may be exceeded only under test conditions).
- Maximum temperature 80°C.
- Maximum bench thickness is 50mm.
- Where normal working pressure exceeds the maximum, pressure limiting valves should be installed.
- Inline filters should be used to protect tapware from debris that may be present within the plumbing.