











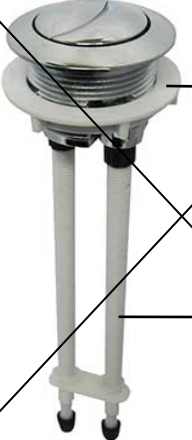



RELATED PRODUCTS



	AU Code	NZ Code	Kohler Code
Panache close coupled 3L/4.5L toilet with quiet close seat	115286	578637	18613A-0

SPARE PARTS - TANK

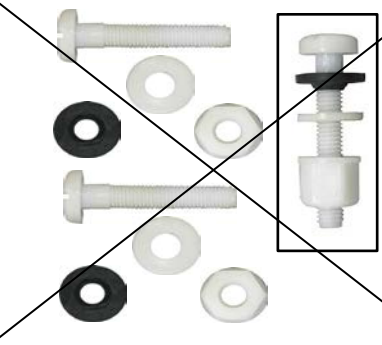
SPARE PART IMAGE	DESCRIPTION	CODES
	<b>Tank lid - Panache</b> - Includes 1 x panache tank lid	Kohler 1044745-0
	<b>Inlet valve - Fluid master</b> - Includes 1 x fluid master inlet valve & 1 x inlet valve seal  - Inlet valve seal can be purchased separately (REF: 56095)	Kohler 6248
	<b>Seal - Inlet valve - Fluid master</b> - Used on fluid master inlet valve (REF: 6248)	Kohler 56095
	<b>Outlet valve - R&amp;T</b> - Includes 1 x outlet valve, 1 x outlet valve seal, 1 x tapered seal washer, 1 x rubber washer, 1 x plastic washer & 1 x plastic nut,  - Outlet valve seal can be purchased separately (REF: 1113323)	Kohler 1101584



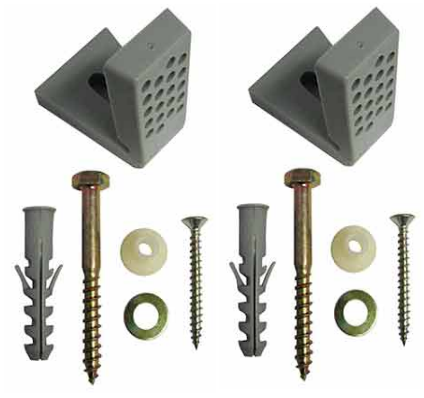

 	<p><b>Seal - Outlet valve - R&amp;T</b>  - Used on R&amp;T outlet valve (REF: 1101584)</p>	<p>Kohler 1113323</p>
  	<p><b>DISCONTINUED: Flush button assembly - Raised</b>  - Includes 1 x button housing, 2 x buttons, 2 x push rods &amp; 1 x plastic nut</p> <p>Replaced by part 1206191 as of 2013</p>	<p><del>Kohler 1102601</del></p>
 	<p><b>DISCONTINUED: Push rods - Flush button assembly - Raised</b>  - Includes 2 x push rods, 1 x connector &amp; 2 x rubber tips</p> <p>- Used on R&amp;T flush button assembly (REF: 1102601)</p> <p>Replaced by part 1206191 as of 2013</p>	<p><del>Kohler 1103320</del></p>
  	<p><b>Flush button assembly - Low Profile</b>  - Includes 1 x button housing, 2 x buttons, 2 x push rods &amp; 1 x plastic nut</p> <p>- Push rod assembly can be purchased separately (REF: 1208135)</p>	<p>Kohler 1206191</p>
 	<p><b>Push rods - Flush button assembly - Low Profile</b>  - Includes 2 x push rods, 1 x connector &amp; 2 x rubber tips</p> <p>- Used on R&amp;T flush button assembly (REF: 1206191)</p>	<p>Kohler 1208135</p>

	<p><b>DISCONTINUED: Fixing kit - Tank to pan - Plastic</b>  - includes 2 x bolts, 2 x nuts, 2 x rubber washers &amp; 2 x plastic washers</p> <p>Replaced by 1185317 as of 2013</p>	<p><del>Kohler 1050618</del></p>
	<p><b>Fixing kit - Tank to pan - Metal</b>  - 2 x bolts, 2 x nuts, 2 x rubber conical washers, 4 x plastic washers &amp; 2 x plastic wing nuts</p> <p>(REPLACES 1050618)</p>	<p>Kohler 1185317</p>
	<p><b>Seal - Tank outlet - Donut type</b>  - Includes 1 x donut seal</p>	<p>Kohler 1065753</p>



SPARE PARTS - PAN		
SPARE PART IMAGE	DESCRIPTION	CODES
	<p><b>Fixing kit - Pan to floor - With brackets</b>  - Includes 2 x brackets, 2 x bolts, 2 x screws, 2 x washers, 2 x anchors &amp; 2 x plastic sleeves</p>	<p>Kohler 1096334</p>
	<p><b>Vario trap</b>  - Includes 1 x vario trap, 1 x wall attachment, 1 x waste outlet seal &amp; 1 x floor waste pipe seal</p> <p>- Floor waste pipe seal can be purchased separately (REF: 1060803)</p>	<p>Kohler 12503A-NA</p>

	<p><b>Seal - Collar - Floor waste pipe</b>  - Used on vario trap (REF: 1060803)</p>	<p><b>Kohler</b> 1060803</p>
---	---	------------------------------

**SPARE PARTS - SEAT - PLASTIC**

SPARE PART IMAGE	DESCRIPTION	CODES
<p>Top view</p>  <p>Side view</p> 	<p><b>Bumper kit - Panache</b>  - Includes 2 x round bumpers, 2 x rectangular bumpers &amp; 2 x bevelled bumpers</p>	<p><b>Kohler</b> 1121373</p>
	<p><b>Hinge bolts - Plastic hinge - Panache</b>  - Includes 2 x bolts &amp; 2 x washers</p>	<p><b>Kohler</b> 1021449</p>
	<p><b>Hinge plates - Plastic hinge - Opiaz</b>  - Includes 2 x plastic hinge plates</p>	<p><b>Kohler</b> 1067242</p>

**SPARE PARTS - SEAT - METAL**

SPARE PART IMAGE	DESCRIPTION	CODES
<p>Top view</p>  <p>Side view</p> 	<p><b>Bumper kit - Panache</b>  - Includes 2 x round bumpers, 2 x rectangular bumpers &amp; 2 x bevelled bumpers</p>	<p><b>Kohler</b> 1121372</p>

	<p><b>Hinge Kit - Quiet close - metal</b></p> <p>- Includes 2 x hinge bolts, 2 x covers, 2 x seals, 2 x Hinge plate &amp; 1 x allen key</p>	<p><b>Kohler</b> 1112827</p>
	<p><b>Damper - Quiet Close - Left hand side - Green</b></p>	<p><b>Kohler</b> 1112831</p>
	<p><b>Damper - Quiet Close - Right hand side - White</b></p>	<p><b>Kohler</b> 1112832</p>
	<p><b>Hinge cover - Quiet Close - Left hand side</b></p> <p>- Includes 1 x hinge cover &amp; 1 x grub screw</p> <p>- Grub screw can be purchased separately (REF: 1112830)</p>	<p><b>Kohler</b> 1112828</p>
	<p><b>Hinge cover - Quiet Close - Right hand side</b></p> <p>- Includes 1 x hinge cover &amp; 1 x grub screw</p> <p>- Grub screw can be purchased separately (REF: 1112830)</p>	<p><b>Kohler</b> 1112829</p>
	<p><b>Grub screw - Hige cover</b></p> <p>- Used on hinge covers (REF:1112828 or REF:1112829)</p>	<p><b>Kohler</b> 1112830</p>