

Note: before cutting countertop
Allow for handle clearance.
注意: 在切割台面之前, 请留出
安装龙头的空间。

FINISHED WALL / BACK SPLASH
完工墙面/防溅挡板

CENTERLINE OF FITTING
安装中线

KOHLER®

K-77762T/K-77776T MODERN LIFE 明莱

VESSEL W/O FAUCET DECK 时尚脸盆(不带龙头档) CUT-OUT TEMPLATE / INSTALLATION INSTRUCTIONS 切割图/安装说明书

Outline
外形轮廓

BEFORE YOU BEGIN

- Observe all local plumbing and building codes.
- Inspect the waste and supply tubing; replace if necessary.
- Prior to installation, unpack the new lavatory and carefully inspect it for damage. Return the lavatory to its protective carton until you are ready to install it.
- For replacement installations, make sure the existing cutout is the same or smaller size as the new lavatory.
- Use the template supplied with the lavatory to mark correct size cutout.
- Kohler lavatory is made according to American National Standard that it can match the American lavatory fittings. Any other lavatory fittings may not fit for Kohler lavatory.
- Fixture dimensions are nominal and conform to tolerances established by ASME Standards (A112.19.2-2013).
- The product complies with GB 6952-2015.

安装之前

- 留意当地所有给排水及建筑规定。
- 检查污水管及供水管, 如有需要请更换。
- 安装之前, 先打开新脸盆的包装, 并小心检查新的脸盆是否有损坏。再将脸盆放回包装盒内, 到安装时才取用。
- 若为更换新脸盆, 须确保现有的柜台孔口与新脸盆的切割位相同或较后者小。
- 请使用同时印在此说明书上的切割图, 标划正确之切割位。
- 科勒洗脸盆是按照美国标准制造的, 与其它洗脸盆配件可能与之不相配。
- 部件尺寸为标称值, 误差符合美国 ASME标准(A112.19.2-2013)。
- 本产品符合GB 6952-2015。

TOOLS AND MATERIALS (Not Supplied)

- Template(supplied)
- Safety glasses
- Pencil
- Scissors
- Tape measure
- Putty knife
- Plumbers putty
- Hacksaw
- Keyhole saw or saber saw
- Drill (13mm or 1/2" dia. drill bit or larger)
- Adjustable wrench
- Pipe wrench
- Tubing cutter

所需工具及物料 (不随货供应)

- 模板(已提供)
- 护眼镜
- 炭笔
- 剪刀
- 卷尺
- 涂油灰刀
- 水管用油灰
- 锯
- 匙孔线锯或手提电锯
- 钻头直径为13mm钻头或更大)
- 活动扳钳
- 喉管扳钳
- 切管刀

ROUGHING-IN

Reference Value
参考值

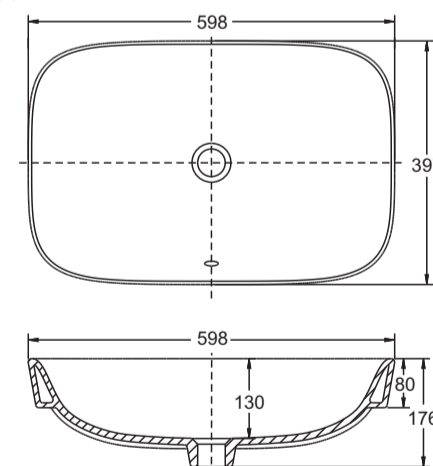

Kohler reserves the right to change marked dimensions without prior notice.
科勒公司保留随时变更图中标示尺寸的权利, 无需另行通知。

尺寸图

Unit: mm
单位: 毫米

	Length 长	Width 宽	Height 高	Depth 盆深
Outer 外尺寸	598	397	176	
Inner 内尺寸	587	386	130	

REMOVE EXISTING LAVATORY

- Turn off the water supply to the faucet.
- Open the faucet valves, then disconnect the supply lines.
- Disconnect the drain assembly and remove the trap.
- Remove the existing lavatory.

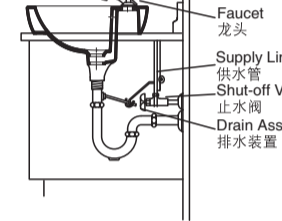

INSTALL NEW LAVATORY

- Cut the template on the cutout line.
- Position the template on the countertop to ensure clearance between the lavatory, faucet, and backsplash.
- Verify cabinet clearance beneath the countertop.

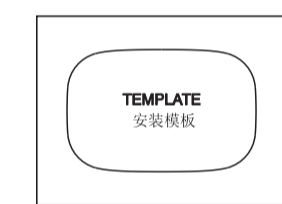

- Trace the template on the countertop with a pencil.
- Re-check the clearance between the lavatory, faucet, backsplash, and cabinet. Adjust the template accordingly.

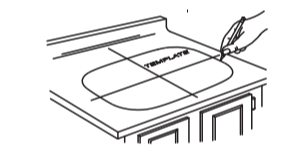

- Drill a 13mm hole on the inside of the cutout opening.
- Cut the opening in the countertop along the inside edge of the pencil line.



- Temporarily position the lavatory in the opening, and adjust to fit.
- CAUTION: Risk of personal injury or product damage.** Large lavatories are very heavy. Get help lifting the lavatory into place.

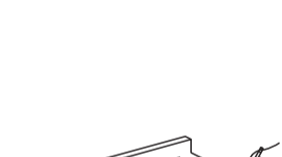

- Trace a pencil line around the outside edge of the lavatory.
- Remove the lavatory.
- Install the faucet and drain according to the manufacturers instructions.



- Apply two beads of sealant to the inside of the pencil line.
- Spread the sealant evenly with a putty knife.

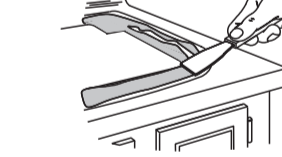

- Carefully position the lavatory in the cutout, and press down firmly.



拆除旧脸盆

- 关掉水龙头的供水源。
- 打开龙头阀门, 然后断开供水管。
- 再旋开排水装置, 并拿开弯管。
- 移走旧脸盆。

安装新脸盆

- 将切割图沿切割线切出。
- 将切割图放在盥洗台上, 确保脸盆、水龙头和防溅挡板之间有足够距离。
- 查核盥洗台下的储物柜也有足够空间。

- 用炭笔沿切割图在盥洗台面划线。
- 再次检查脸盆、水龙头、防溅板及储物柜的空间及距离。如有需要可调整切割图的位置。

- 用一个13mm的钻头, 在切割口内侧钻一个导孔。
- 沿着自切割图勾划出来的铅笔线内侧切开台面。

- 暂将脸盆放入台面开口, 校正位置。

- 小心:** 提防身体受伤或损坏产品。因大型脸盆相当重, 需找人帮您一起搬动及安放。

- 用炭笔沿脸盆外缘在盥洗台上划线。
- 然后将脸盆移开。
- 按照制造商的指引, 安装水龙头和排水管道。

- 沿炭笔导线内侧涂两滴密封胶。
- 用涂油灰刀将其抹匀。

- 小心地将脸盆置于台面切口适当位置, 向下按牢。

CAUTION: Risk of personal injury or product damage. Large lavatories are very heavy. Get help lifting the lavatory into place.

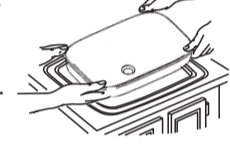

- Immediately wipe away any excess sealant, and fill any voids as needed.
- Verify that the lavatory has not moved out of position.
- Allow the sealant to cure for at least 30 minutes before proceeding.
- Connect the faucet supply lines.
- Connect the drain assembly.
- Open the faucet valves, and check for leakage.
- Clean up with a non-abrasive cleaner.



IMPORTANT CONSUMER INFORMATION (CARE AND CLEANING)

To keep your lavatory looking new, make sure you rinse it out thoroughly after each use. **DO NOT USE ABRASIVES** on this product, as they will scratch and ruin the surface. Stubborn stains, paint, or tar can be removed with turpentine or paint thinner.

Do not use the product in the water below 0°C.

CAUTION: Please do not use hard materials (like scouring pad) to clean product surface, especially the product logo.

用户须知 (护理和清洁)

为保持脸盆光泽如新, 须确保每次使用后彻底冲洗干净。切勿使用腐蚀性的清洁剂, 以免刮花及破坏脸盆的表面。要清除顽固污垢, 油漆或柏油, 可使用松油或油漆稀释剂。

不要在0°C以下的水环境中使用。

警告: 请勿使用钢丝球等硬质材料擦洗产品表面, 特别是产品商标处。

